

ePMP 4500 Series Access Points

ePMP 4500 Series AP Quick Look

- High-performance, scalable, reliable
- MU-MIMO and up to 4 Gbps in performance
- Low TCO and 3-year hardware warranty
- Interoperable with Force 400 and Force 300

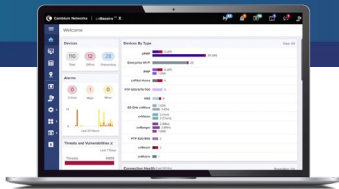

Cambium Networks ePMP™ product line has set the standard for high performance, scalability, and reliability in harsh interference environments, all at a compelling price. ePMP 4500 Access Points (AP) interoperate with Force 400 Subscriber Modules (SM) and support backward compatibility to Force 300 Subscriber modules.* A sophisticated scheduling and Quality of Service (QoS) engine combined with TDD synchronization allows ePMP 4500 APs to deliver consistently high-quality service plans to a large number of end users.

All ePMP 4500 Series APs are managed with cnMaestro™, and networks can be planned with LINKPlanner. Both are available from Cambium Networks at no charge.

ePMP 4500

The ePMP 4500 delivers up to 4 Gbps and supports up to 120 subscriber modules. Featuring 8x8 MU-MIMO, the 5 GHz ePMP 4500 can transmit to four Force 400 SMs at the same time. This effectively quadruples the capacity of 2x2 systems and in the process, increases link budgets by 6 dB with downlink beamforming. The ePMP 4500 has an integrated 90° 8x8 MU-MIMO sector antenna. With TDD synchronization, ePMP 4500 networks can scale to thousands of end users leveraging a small number of channels.

ePMP 4500C

The ePMP 4500C features the same radio as ePMP 4500 but without the integrated antenna, allowing the end user to install their own sectored antennas or horns.

ePMP 4500L

The ePMP 4500L 2x2 MIMO AP is connectorized with two RP-SMA for use with Cambium 90°/120° Degree Sector Antenna. This unit is also compatible with RF Elements Twistport™ adaptor for ePMP. Featuring the latest 1024QAM and 80 MHz channel bandwidth technology, these access points deliver performance above 1 Gbps.

*Force 300 backward compatibility to be supported in future firmware release.

ePMP 4500 Series Access Points

Spectrum and Interface			
	ePMP 4500	ePMP 4500C	ePMP 4500L
Channel Width	20 40 80 MHz	20 40 80 MHz	20 40 80 MHz
Proprietary Physical Layer	8x8 MU-MIMO/OFDMA based on 802.11ax underlying technology	8x8 MU-MIMO/OFDMA based on 802.11ax underlying technology	2x2 MIMO/OFDMA based on 802.11ax underlying technology
Channel Spacing	Configurable in 5 MHz increments	Configurable in 5 MHz increments	Configurable in 5 MHz increments
Frequency Range	Wide band operation 4910–6135 MHz <small>(Note: Allowable frequencies and bands are dictated by individual country regulations.)</small>	Wide band operation 4910–6135 MHz	Wide band operation 4910–6135 MHz
MAC Layer (Media Access Control)	Cambium proprietary	Cambium proprietary	Cambium proprietary
Ethernet Interfaced	100/1000 BaseT, rate auto negotiated, 802.3bt compliant & Aux SFP+ port	100/1000 BaseT, rate auto negotiated, 802.3bt compliant & Aux SFP+ port	100/1000 BaseT, rate auto negotiated, 802.3at compliant & Aux SFP+ port
Supported Powering Methods	56V 60W PoE (included), standard 802.3bt PoE Supply, or cnMatrix Tower Switch, or wired DC input	56V 60W PoE (included), standard 802.3bt PoE Supply, or cnMatrix Tower Switch, or wired DC input	56V 30W PoE (included), standard 802.3at PoE Supply, or cnMatrix Tower Switch
Protocols Used	IPv4/IPV6, UDP, TCP, IP, ICMP, SNMPv2c, HTTPs, STP, SSH, IGMP snooping	IPv4/IPV6, UDP, TCP, IP, ICMP, SNMPv2c, HTTPs, STP, SSH, IGMP snooping	IPv4/IPV6, UDP, TCP, IP, ICMP, SNMPv2c, HTTPs, STP, SSH, IGMP snooping
Network Management	HTTPS, SNMPv2c, SSH	HTTPS, SNMPv2c, SSH	HTTPS, SNMPv2c, SSH
VLAN	802.1Q with 802.1p priority	802.1Q with 802.1p priority	802.1Q with 802.1p priority

Performance			
	ePMP 4500	ePMP 4500C	ePMP 4500L
Subscribers per Sector	Up to 120	Up to 120	Up to 120
ARQ	Yes	Yes	Yes
Nominal Receive Sensitivity (w/FEC) @20 MHz Channel	MCS 0 = -91 dBm to MCS 11 (1024 QAM-5/6) = -62 dBm (per chain)	MCS 0 = -91 dBm to MCS 11 (1024 QAM-5/6) = -62 dBm (per chain)	MCS 0 = -93 dBm to MCS 11 (1024 QAM-5/6) = -63 dBm (per chain)
Nominal Receive Sensitivity (w/FEC) @40 MHz Channel	MCS 0 = -88 dBm to MCS 11 (1024 QAM-5/6) = -59 dBm (per chain)	MCS 0 = -88 dBm to MCS 11 (1024 QAM-5/6) = -59 dBm (per chain)	MCS 0 = -90 dBm to MCS 11 (1024 QAM-5/6) = -60 dBm (per chain)
Nominal Receive Sensitivity (w/FEC) @80 MHz Channel	MCS 0 = -85 dBm to MCS 11 (1024 QAM-5/6) = -57dBm (per chain)	MCS 0 = -85 dBm to MCS 11 (1024 QAM-5/6) = -57dBm (per chain)	MCS 0 = -87 dBm to MCS 11 (1024 QAM-5/6) = -57dBm (per chain)
Modulation Levels (Adaptive)	MCS 0 (BPSK) to MCS 11 (1024 QAM-5/6)	MCS 0 (BPSK) to MCS 11 (1024 QAM-5/6)	MCS 0 (BPSK) to MCS 11 (1024 QAM-5/6)
GPS Synchronization	Yes, via internal GPS or Cambium Sync	Yes, via internal GPS or Cambium Sync	Yes, via internal GPS
QoS (Quality of Service)	Three level priority (voice, high, low) with packet classification by DSCP, COS, VLAN ID, IP & MAC address, broadcast, multicast, and station priority	Three level priority (voice, high, low) with packet classification by DSCP, COS, VLAN ID, IP & MAC address, broadcast, multicast, and station priority	Three level priority (voice, high, low) with packet classification by DSCP, COS, VLAN ID, IP & MAC address, broadcast, multicast, and station priority, mir/cir support
Transmit Power Range	0 to +34 dBm (combined, to regional EIRP limit) (1 dB interval)	0 to +33 dBm (combined, to regional EIRP limit) (1 dB interval)	0 to +28 dBm (combined, to regional EIRP limit) (1 dB interval)
Antenna	Integrated 8x8 MU-MIMO 90° Sector 17 dBi gain	N/A	90°/120° 2x2 Sector Antenna (C050900D021B)

ePMP 4500 Series Access Points

Physical

	ePMP 4500	ePMP 4500C	ePMP 4500L
Surge Suppression	1 joule integrated	1 joule integrated	1 joule integrated
Environmental	IP67	IP67	IP67
Temperature	-40°C to 55°C (-40°F to 131°F)	-40°C to 55°C (-40°F to 131°F)	-40°C to 55°C (-40°F to 131°F)
Weight	14.66 kg (32.32 lb) with clamp	TBD kg (TBD lb) with clamp	1.3 kg (2.9 lb)
Dimensions (H x W x D)	643 x 487 x 157 mm (25.3 x 19.2 x 6.2 in)	356 x 284 x 74 mm (14.0 x 11.2 x 2.9 in)	256 x 125 x 47 mm (10.1 x 4.9 x 1.9 in)
Power Consumption	32W maximum	32W maximum	28W maximum
Input Voltage	44V to 59V	44V to 59V	44V to 59V
Sector Antenna Connection	Integrated 90° Sector	8 x 50 ohm, RP (Reverse Polarity) SMA	2 x 50 ohm, RP (Reverse Polarity) SMA Also compatible with RF Elements Twistport™ Adaptor for ePMP
Antenna Gain	17dB	N/A	N/A
3dB Beamwidth Azimuth	85°	N/A	N/A
3dB Beamwidth Elevation	5.5°	N/A	N/A
Front/Back Ratio	32 dB	N/A	N/A
Port-Port Isolation	>30 dB	N/A	N/A
GPS Antenna Connection	1 x 50 ohm, SMA; Integrated GPS Antenna	1 x 50 ohm, SMA; external GPS External GPS Puck included in packaging	1 x 50 ohm, SMA; external GPS External GPS Puck included in packaging

Security

Specs in this table apply to all models, except where noted.

Encryption	128-bit AES (CCMP mode)
------------	-------------------------

Certifications

	ePMP 4500	ePMP 4500C	ePMP 4500L
FCCID	Z8H89FT0065	Z8H89FT0065	Z8H89FT0062
Industry Canada Cert	109W-0065	109W-0065	109W-0062
CE	See Cambium website for Declaration of Conformity	See Cambium website for Declaration of Conformity	See Cambium website for Declaration of Conformity

ePMP 4500 Series Access Points

ePMP 4500

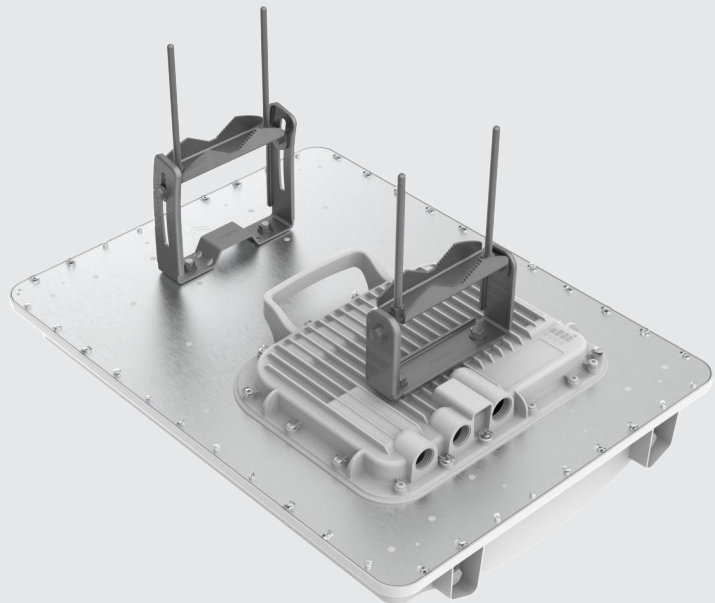
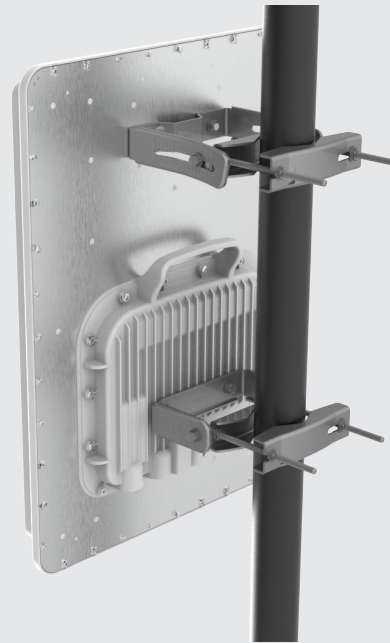

ePMP 4500 Series Access Points

ePMP 4500C

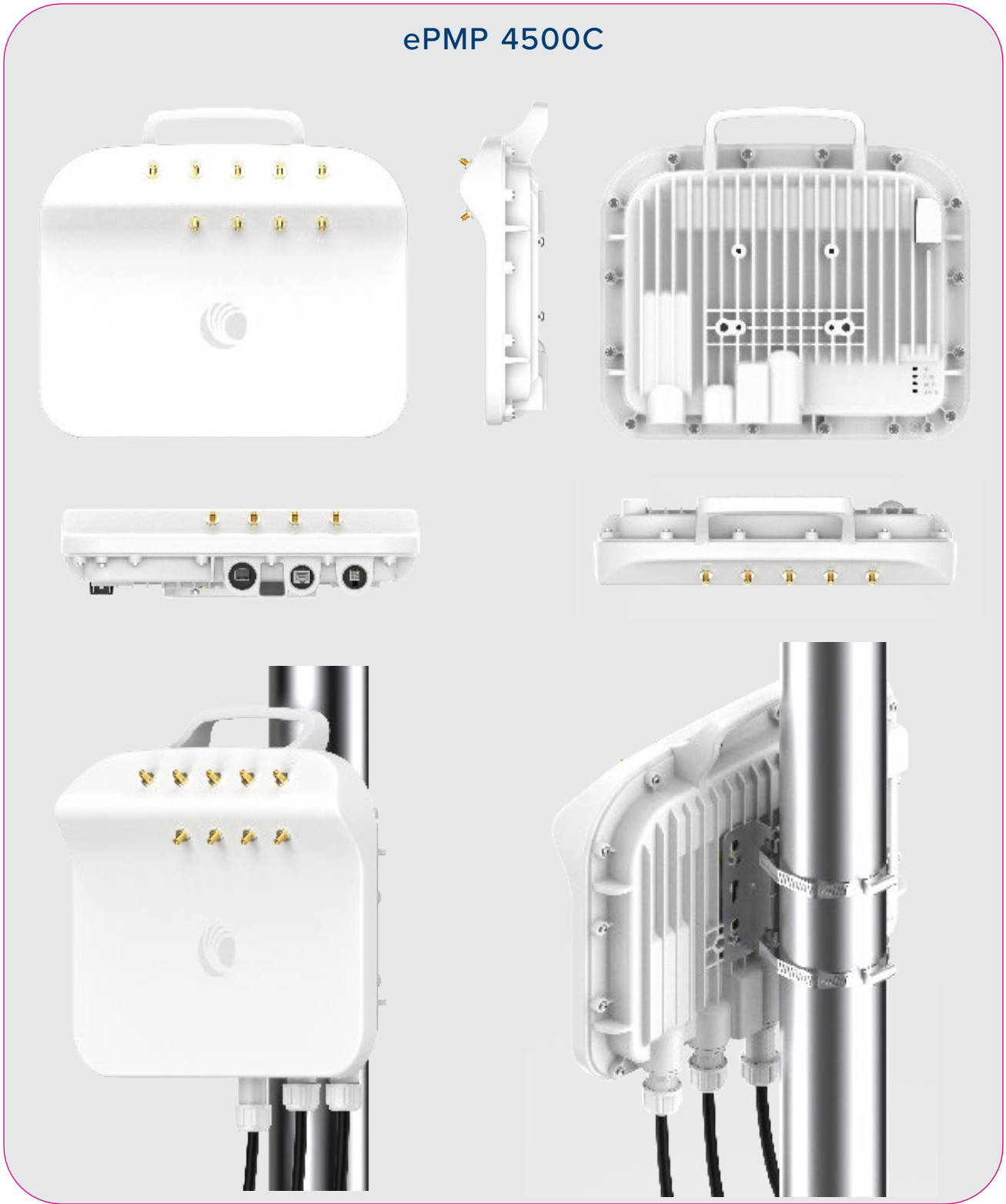

ePMP 4500 Series Access Points

ePMP 4500L



ePMP 4500 Series Access Points

Antenna Patterns

CH 0 Horizontal Polarization, Azimuth

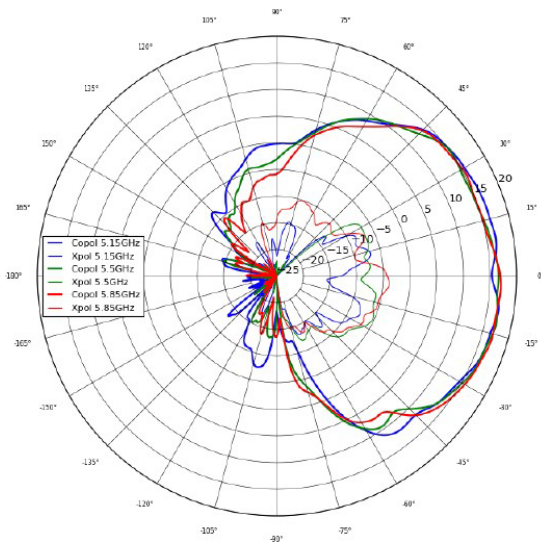

CH 0 Horizontal Polarization, Elevation

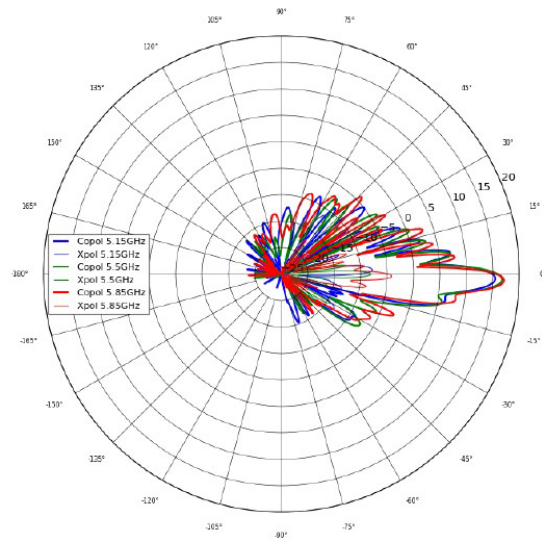

CH 1 Vertical Polarization, Azimuth

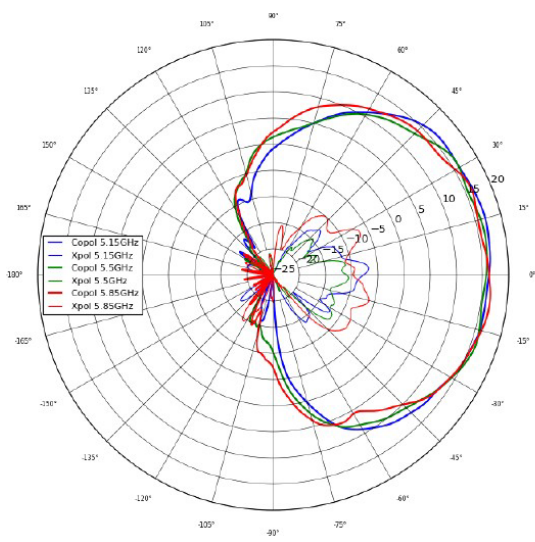

CH 1 Vertical Polarization, Elevation

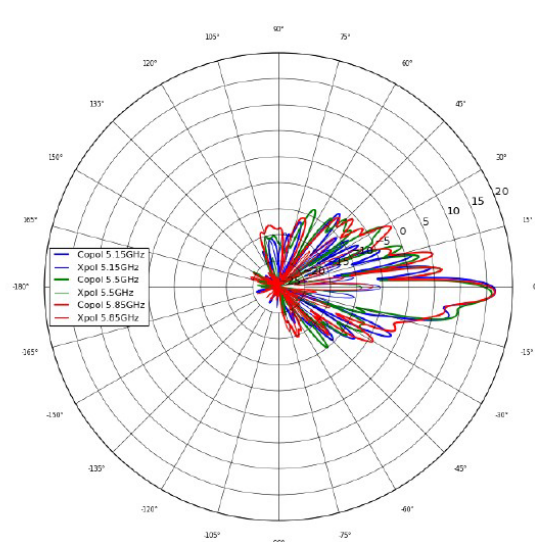

ePMP 4500 Series Access Points

Antenna Patterns, continued

CH 2 Horizontal Polarization, Azimuth

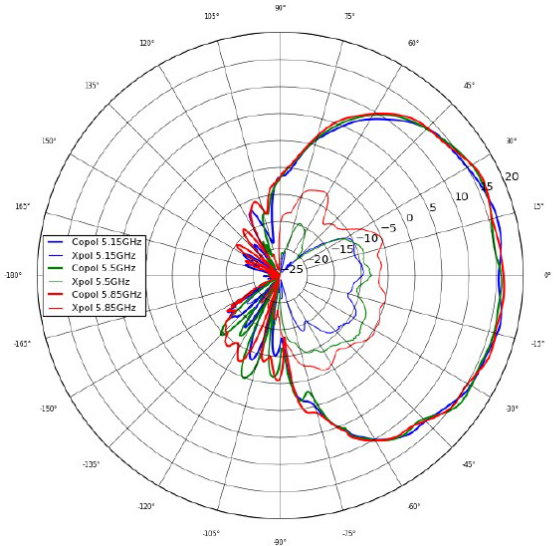

CH 2 Horizontal Polarization, Elevation

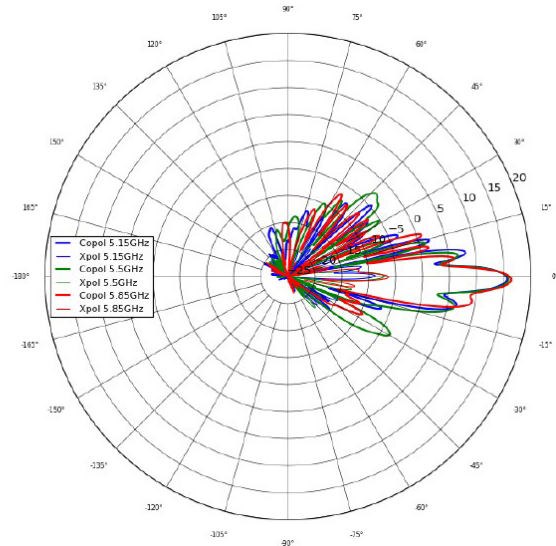

CH 3 Vertical Polarization, Azimuth

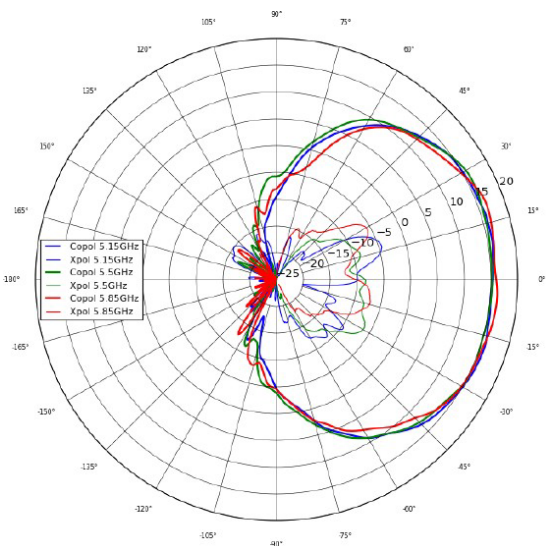

CH 3 Vertical Polarization, Elevation

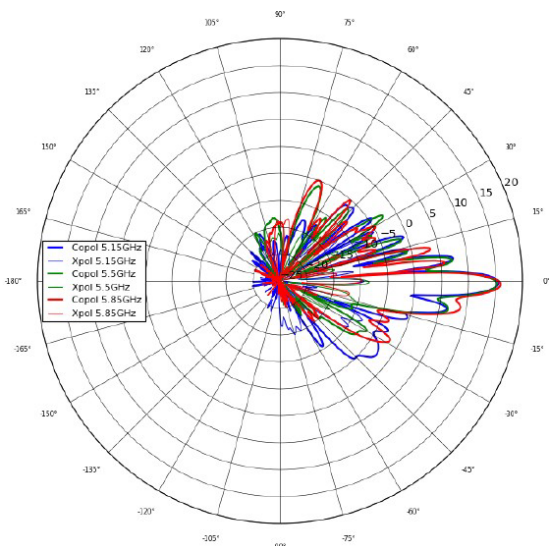

ePMP 4500 Series Access Points

Antenna Patterns, continued

CH 4 Horizontal Polarization, Azimuth

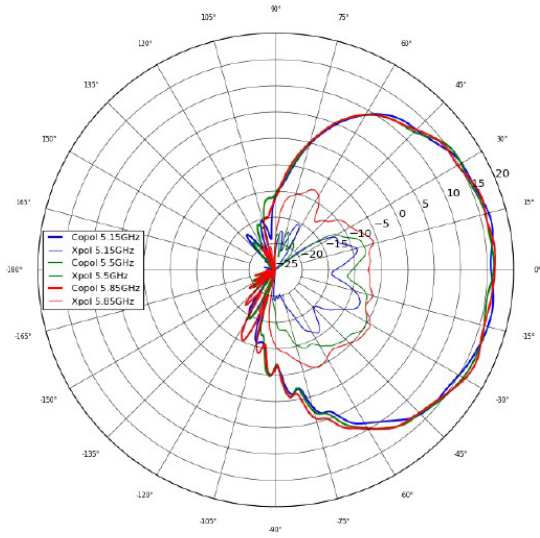

CH 4 Horizontal Polarization, Elevation

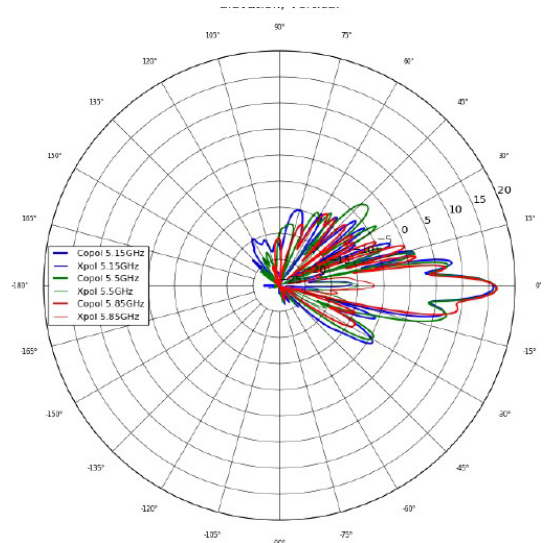

CH 5 Vertical Polarization, Azimuth

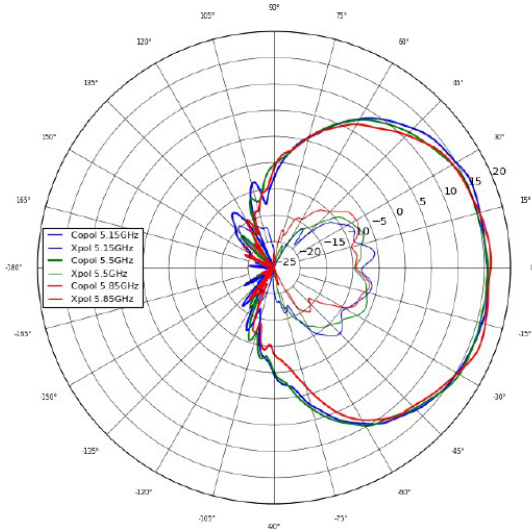

CH 5 Vertical Polarization, Elevation

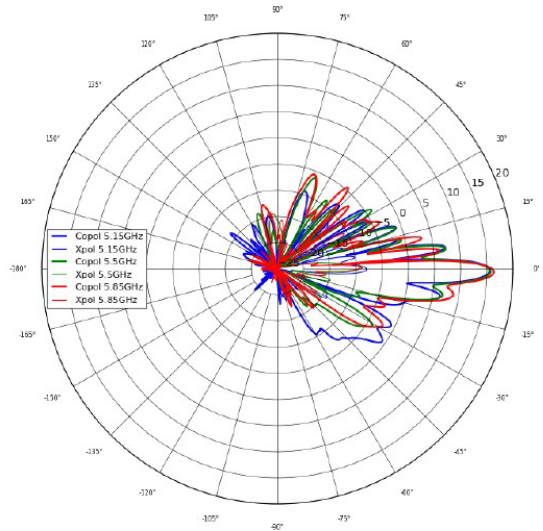

ePMP 4500 Series Access Points

Antenna Patterns, continued

CH 6 Horizontal Polarization, Azimuth

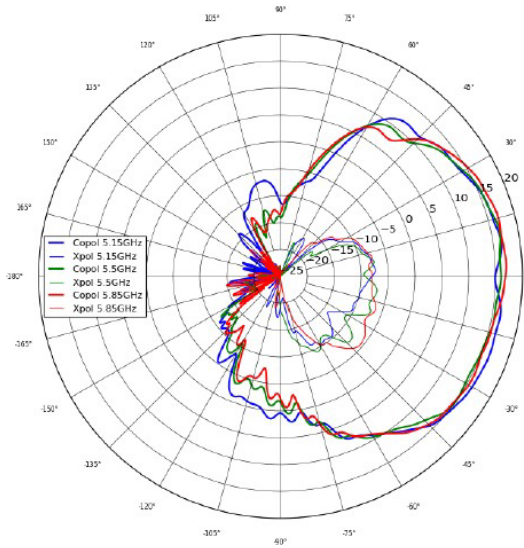

CH 6 Horizontal Polarization, Elevation

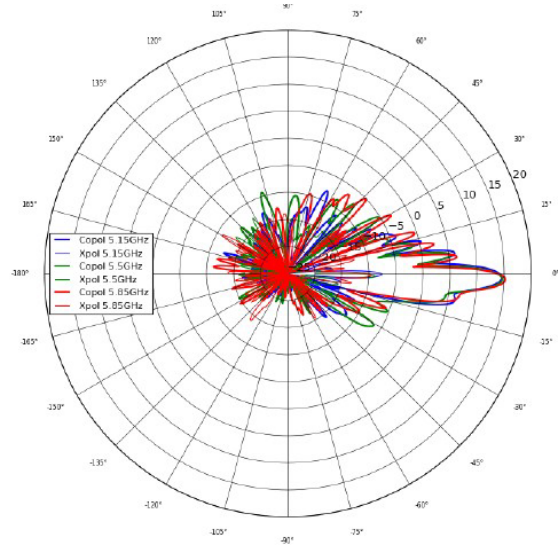

CH 7 Vertical Polarization, Azimuth

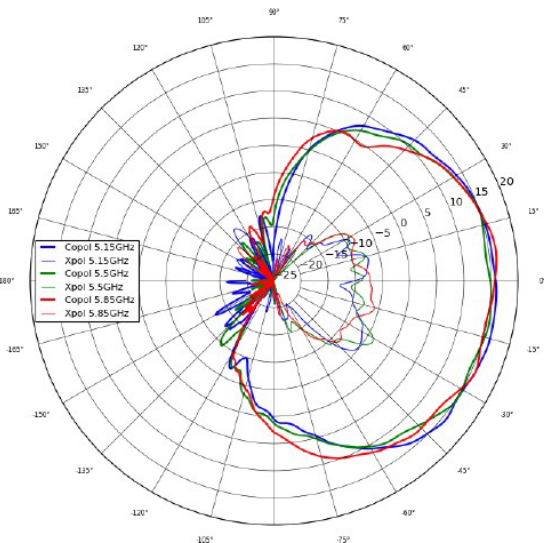

CH 7 Vertical Polarization, Elevation

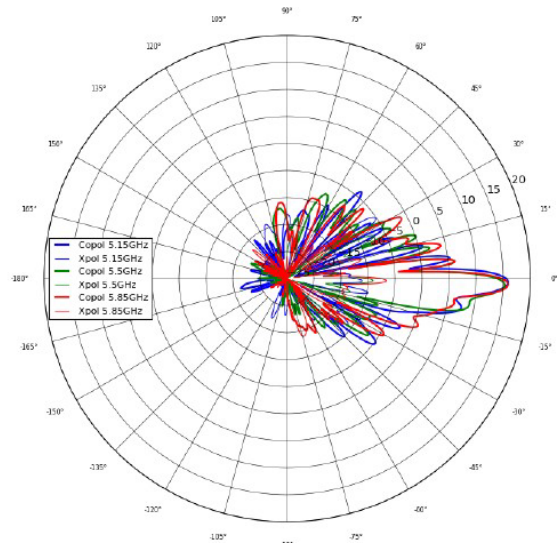

ePMP 4500 Series Access Points

Ordering Information			
ePMP 4500		ePMP 4500C	
C050940A021A	ePMP 4500 5 GHz 8x8 Access Point Radio (ROW) (no cord)	C050940A011B	ePMP 4500C 5 GHz Access Point Radio (ROW) (no cord)
C050940A121A	ePMP 4500 5 GHz 8x8 Access Point Radio (ROW) (US cord)	C050940A111B	ePMP 4500C 5 GHz Access Point Radio (ROW) (US cord)
C058940A124A	ePMP 4500 5 GHz 8x8 Access Point Radio (IC) (Canada/US cord)	C058940A114B	ePMP 4500C 5 GHz Access Point Radio (IC) (Canada/US cord)
C050940A221A	ePMP 4500 5 GHz 8x8 Access Point Radio (ROW) (EU cord)	C050940A211B	ePMP 4500C 5 GHz Access Point Radio (ROW) (EU cord)
C050940A223A	ePMP 4500 5 GHz 8x8 Access Point Radio (EU) EU cord)	C050940A213B	ePMP 4500C 5 GHz Access Point Radio (EU) (EU cord)
C050940A321A	ePMP 4500 5 GHz 8x8 Access Point Radio (ROW) (UK cord)	C050940A311B	ePMP 4500C 5 GHz Access Point Radio (ROW) (UK cord)
C050940A323A	ePMP 4500 5 GHz 8x8 Access Point Radio (EU) (UK cord)	C050940A313B	ePMP 4500C 5 GHz Access Point Radio (EU) (UK cord)
C050940A421A	ePMP 4500 5 GHz 8x8 Access Point Radio (ROW) (India cord)	C050940A411B	ePMP 4500C 5 GHz Access Point Radio (ROW) (India cord)
C050940A425A	ePMP 4500 5 GHz 8x8 Access Point Radio (India) (India Cord)	C050940A415B	ePMP 4500C 5 GHz Access Point Radio (India) (India Cord)
C050940A521A	ePMP 4500 5 GHz 8x8 Access Point Radio (ROW) (China cord)	C050940A511B	ePMP 4500C 5 GHz Access Point Radio (ROW) (China cord)
C050940A621A	ePMP 4500 5 GHz 8x8 Access Point Radio (ROW) (Brazil cord)	C050940A611B	ePMP 4500C 5 GHz Access Point Radio (ROW) (Brazil cord)
C050940A721A	ePMP 4500 5 GHz 8x8 Access Point Radio (ROW) (Argentina cord)	C050940A711B	ePMP 4500C 5 GHz Access Point Radio (ROW) (Argentina cord)
C050940A821A	ePMP 4500 5 GHz 8x8 Access Point Radio (ROW) (ANZ cord)	C050940A811B	ePMP 4500C 5 GHz Access Point Radio (ROW) (ANZ cord)
C050940A921A	ePMP 4500 5 GHz 8x8 Access Point Radio (ROW) (South Africa cord)	C050940A911B	ePMP 4500C 5 GHz Access Point Radio (ROW) (South Africa cord)
C050940AZ21A	ePMP 4500 5 GHz 8x8 Access Point Radio (ROW) (No PSU)	C058940A112B	ePMP 4500C 5 GHz Access Point Radio (FCC) (US cord)
C058940A122A	ePMP 4500 5 GHz 8x8 Access Point Radio (FCC) (US cord)	C050940A216BA	ePMP 4500C 5 GHz Access Point Radio (Indonesia) (EU Cord)
C050940A226A	ePMP 4500 5 GHz 8x8 Access Point Radio (Indonesia) (EU Cord)		

ePMP 4500 Series Access Points

Ordering Information

ePMP 4500L

C050940A061B	ePMP 4500L 5 GHz 2x2 Access Point Radio (ROW) (no cord)
C050940A161B	ePMP 4500L 5 GHz 2x2 Access Point Radio (ROW) (US cord)
C058940A164B	ePMP 4500L 5 GHz 2x2 Access Point Radio (IC) (Canada/US cord)
C050940A261B	ePMP 4500L 5 GHz 2x2 Access Point Radio (ROW) (EU cord)
C050940A263B	ePMP 4500L 5 GHz 2x2 Access Point Radio (EU) (EU cord)
C050940A361B	ePMP 4500L 5 GHz 2x2 Access Point Radio (ROW) (UK cord)
C050940A363B	ePMP 4500L 5 GHz 2x2 Access Point Radio (EU) (UK cord)
C050940A461B	ePMP 4500L 5 GHz 2x2 Access Point Radio (ROW) (India cord)
C050940A465B	ePMP 4500L 5 GHz 2x2 Access Point Radio (India) (India Cord)
C050940A561B	ePMP 4500L 5 GHz 2x2 Access Point Radio (ROW) (China cord)
C050940A661B	ePMP 4500L 5 GHz 2x2 Access Point Radio (ROW) (Brazil cord)
C050940A761B	ePMP 4500L 5 GHz 2x2 Access Point Radio (ROW) (Argentina cord)
C050940A861B	ePMP 4500L 5 GHz 2x2 Access Point Radio (ROW) (ANZ cord)
C050940A961B	ePMP 4500L 5 GHz 2x2 Access Point Radio (ROW) (South Africa cord)
C058940A162B	ePMP 4500L 5 GHz 2x2 Access Point Radio (FCC (US cord)
C050940A266B	ePMP 4500L 5 GHz 2x2 Access Point Radio (Indonesia) (EU Cord)

About Cambium Networks

Cambium Networks enables service providers, enterprises, industrial organizations, and governments to deliver exceptional digital experiences and device connectivity with compelling economics. Our ONE Network platform simplifies management of Cambium Networks' wired and wireless broadband and network edge technologies. Our customers can focus more resources on managing their business rather than the network. We make connectivity that just works.

cambiumnetworks.com